

Interfacing Two 16-Bit AD1856 (AD1851) Audio DACs with the Philips SAA7220 Digital Filter

by Kevin Greene

INTRODUCTION

The AD1856 is a complete 16-bit DAC used primarily for digital audio applications. The AD1851 is a lower noise, second generation version of the AD1856. Each device provides a voltage output amplifier, 16-bit DAC, 16-bit serial-to-parallel input register, and voltage reference. The AD1856 is specified to operate with $\pm 5\text{ V}$ to $\pm 12\text{ V}$ supplies and achieves a *maximum* of 0.0025% total harmonic distortion (THD). The AD1851 operates with $\pm 5\text{ V}$ supplies and has a *maximum* of 0.004% total harmonic distortion + noise (THD + N), and a signal-to-noise ratio (SNR) of at least 107 dB. Their performance and ease of use make the AD1856/AD1851 popular choices for 16-bit audio designs.

The Philips SAA7220 is a $4\times$ oversampling digital interpolating filter. Some listeners prefer the sound quality of this filter over other digital filters on the market. The SAA7220 features attenuation correction in the audio passband. Other digital filters typically do not incorporate this feature making it difficult, if not impossible, to achieve a flat frequency response using a Butterworth or Bessel filter. These features make the SAA7220 a popular choice for system designers.

The combination of the AD1856/AD1851 with the SAA7220 yields a system with very low THD + N and an excellent SNR. If a Bessel (also known as Thompson) filter is used, the transient response will be exceptional as well. Figure 1 shows a block diagram of the system. Unfortunately, the output interface of the SAA7220 is compatible with I²S format, while the AD1856/AD1851 has a standard 3-line interface.

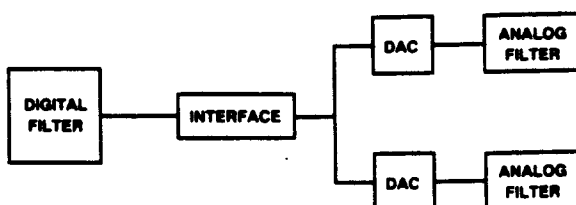

Figure 1. Block Diagram of System

INTERFACE

The interface needs to take the SAA7220 output, which conforms to I²S format (see Figure 2a), and modify it to match the input requirements of the AD1856/AD1851.

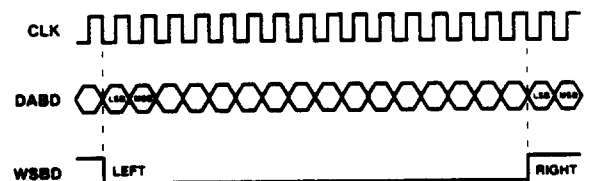

Figure 2a. Output of SAA7220

Three signals must be present for proper operation of the AD1856/AD1851: Data, Clock, and Latch Enable. These signals are shown in Figure 2b. Bringing Latch Enable low after the least significant bit of any word latches the previous 16 bits and starts the conversion.

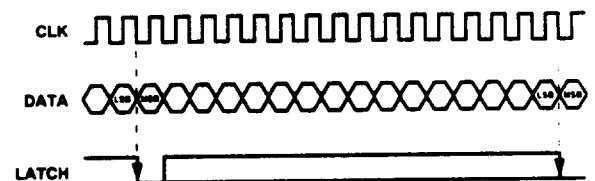

Figure 2b. Signal Requirements for AD1856 (AD1851)

In order for the AD1856/AD1851 to be compatible with the SAA7220, the interface must delay the WSBD line by one clock cycle, gate the clock on the left channel, and simultaneously latch both DACs to eliminate any phase shifts between channels. A quad NAND gate and a dual D flip-flop accomplish this as shown in Figure 3.

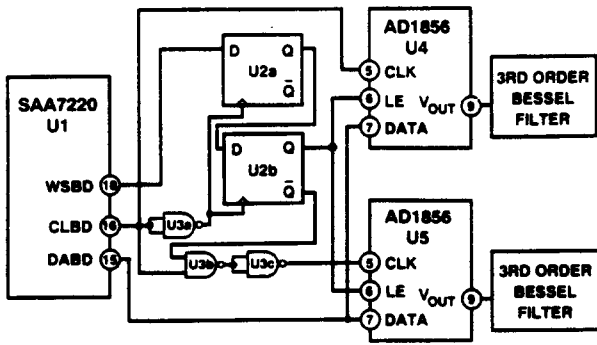

Figure 3. Interface of the SAA7220 and AD1856 (AD1851)

CIRCUIT DESCRIPTION

Data bits are valid on the negative edge of the clock. The D flip-flops are positive-edge triggered, therefore one NAND gate (U3a) is used to invert the clock to the flip-flops. Referring to Figure 2a, WSBD goes low one clock cycle prior to the LSB. Figure 2b shows LATCH going low after the LSB. The flip-flops delay WSBD by one clock cycle, similar to a shift register, to correct this mismatch. The other two NAND gates (U3b and U3c) are used to form an AND gate to gate the clock to the left channel DAC (U5). The SAA7220 transmits serial data, left channel first, followed by right data. WSBD is low during left data transmission. Using \bar{Q} of U2b, the AND gate is "on" during the left data transmission. Therefore both DACs clock in the 16 left channel bits. During the transmission of right data, WSBD goes high (\bar{Q} goes low), turning "off" the clock to U5. Only the right channel (U4) clocks in the right data. After the LSB of right data is clocked into U4, both DACs can be simultaneously latched from the Q output of U2b.

PASSBAND ATTENUATION

All ripple-free low-pass filters have attenuation in the passband similar to Figure 4a. Typically, the corner frequency is approximately 30 kHz for many audio circuits. This results in signal attenuation at 20 kHz. The SAA7220 provides 1.0 dB of digital pre-emphasis in the 20 kHz passband with attenuation in the stopband as shown in Figure 4b. If the analog filter is designed such that the magnitude is 1 dB down at 20 kHz, the combined response will theoretically be flat in the passband as shown in Figure 4c.

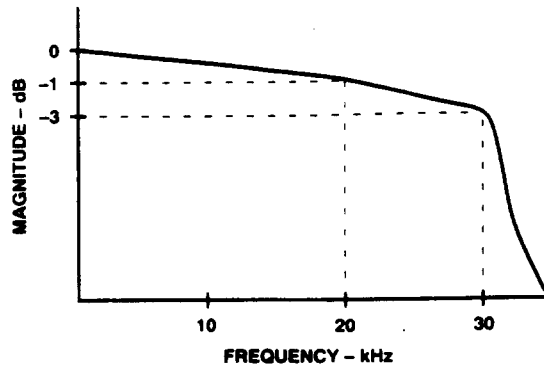

Figure 4a. Analog Filter Response

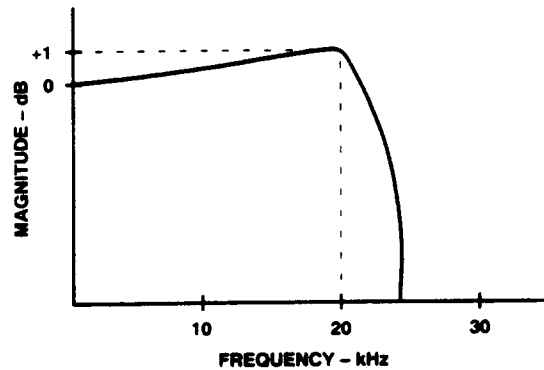

Figure 4b. Digital Filter Response

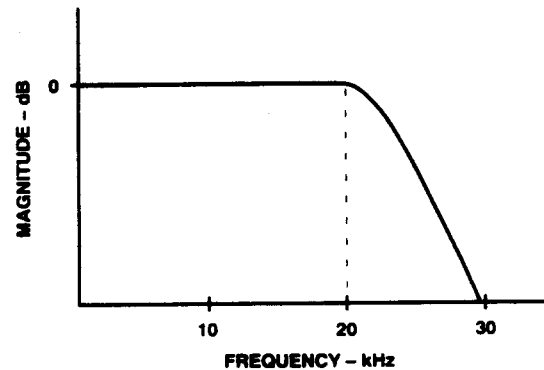

Figure 4c. Combined Response

Normally, Chebyshev or Elliptic filters, with very low ripple, would be required to achieve a flat response. However, these filters inherently have a poor transient response. A Bessel filter, which is optimized for linear phase, has essentially no overshoot or ringing associated with its step response. Additionally, the impulse response lacks oscillatory behavior. The Elliptic, Chebyshev, and even Butterworth filters all suffer from these shortcomings. The improvement in the transient response reduces the distortion of the overall circuit.

Figure 5 shows one such Bessel filter architecture. It's a 3rd order Sallen and Key filter with the -1 dB point of about 20 kHz. An advantage of this filter is that it uses only one op amp which reduces the component cost. A disadvantage is that the sensitivity (the change in magnitude to variations in the component values) increases dramatically as the order of the filter increases. The sensitivity of a third order filter is usually acceptable. Additionally, the capacitor values need to be modified to match available values. This causes the filter to roll-off slightly more than 1 dB at 20 kHz. Another design possibility is to use two op amps, cascading a two-pole filter and a one-pole filter. This would reduce the sensitivity of the filter and possibly achieve a more accurate -1 dB point.

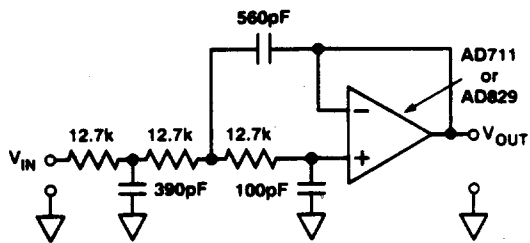

Figure 5. 3rd Order Bessel Filter

RESULTS

By combining the SAA7220's digital filter, the AD1856 (or even better, the AD1851), and a Bessel filter, an excellent system can be achieved. The result is a circuit with THD - N and SNR specifications comparable to the highest quality systems using Butterworth or Bessel filters, but additionally offering the flat frequency response of a system using a Chebyshev or Elliptic filter.

ACKNOWLEDGMENTS

To Bill Thompson for his input. To Steve Ruscak for his input and help throughout the project.

REFERENCES

1. L.P. Huelsman and P.E. Allen, *Introduction to the Theory and Design of Active Filters*, McGraw-Hill Publication Number: ISBN 0-07-030854-3.
2. Arthur B. Williams, *Electronic Filter Design Handbook*, McGraw-Hill Publication Number: ISBN 0-07-070430-9.